

# HANOMAG Sdkfz 251/1

1/35 MILITARY MINIATURE SERIES



When the morning mists before sunrise were still hovering over the field, 500 tanks broke through the German Hindenburg Line near Cambrai in Central France which consisted of three lines of strong points. It was on 20th November, 1917, i.e. the third year of World War I. The Hindenburg Line, whose impregnability the Germans were proud of, had successfully repelled fierce attacks from the combined forces of Britain and France that continued for about three months so far. The two Allied Powers had already lost there over 250,000 in killed and wounded. All battle lines had come to a deadlock and an increasing number of officers and men on both sides had been gassed. Trench warfare which characterized World War I had been under way on every front and soldiers had fought lying flat on the ground. In order to break the gloomy deadlock, British tanks started advancing. At a provoking speed of only 3 km/h, they invaded German area about 5 km in depth and 10 km in width. It seemed as if the attack would succeed but the tanks could not advance any further. The Allies had previously allotted in detail a role in this operation to each arm of service. Tanks were to play the leading role in a rush, while infantry and cavalry were to take charge of a pursuit battle to ensure victory and improve the fruits of battle. In practice, however, the infantry and cavalry which should have followed the tanks did not show themselves at all. Being divided into small groups, German machine-gun corps warded off attacks from the British tanks and made fierce attacks against the infantry and cavalry which tried to follow the tanks. Thus, the tanks were isolated and also the infantry and cavalry were forced to fight independently.

This battle furnished an important lesson on tank tactics as in the following: The tank is an offensive weapon and must make speedy attacks

at the spearhead of an advance. After the tank has broken through the enemy line, infantry must give chase to the enemy and improve the fruits of battle. The most important point is that infantry should be mechanized so that they are mobile enough to keep pace with the tank.

Paying attention to this point, the British developed, on the basis of Colonel Fuller's idea, the Infantry Carrier Mk IX, a rhombic tank carrying 50 men. This was the first infantry vehicle for mechanization. In Germany, on the other hand, Adolf Hitler took power and organized the Reichswehr in 1933. He immediately began to mechanize his army. As early as the beginning of 1920's, the German Army had planned to develop military transport vehicles and heavy-gun tractors to take the place of horses on the basis of non-military vehicles. In Germany of those days, half tracks as well as lorries were widely used in agriculture and public works. The German military authorities paid attention to the good maneuverability and cross-country ability of the half tracks and in 1932 ordered manufacturers to develop military half tracks. They were classed into under 1 ton, 3 tons, 5 tons, 8 tons, 12 tons and 18 tons according to their tractive force. Each of the manufacturers was to develop one of these six classes.

Hansa-Lloyd-Goliath (AG) was in charge of the 3-ton half track and completed a prototype in 1934. It mounted a series 6-cylinder 3.5-litre engine of Borgward on the rear. The front was of such design that permitted subsequent fixing of armour plates. This vehicle was officially designated Sdkfz-11 but often called HL-KL-1. 505 units including the KL-2 and the KL-3 were produced by 1936 and supplied mainly to cavalry reconnaissance companies.

When German tank divisions were organized in 1935, the Germans naturally started development

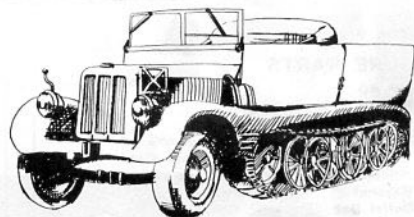

Sdkfz 11

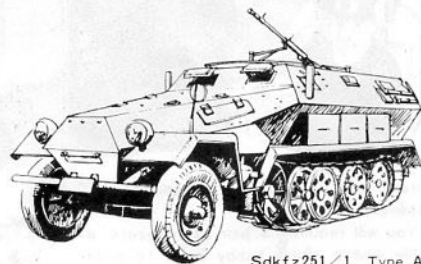

Sdkfz 251/1 Type A

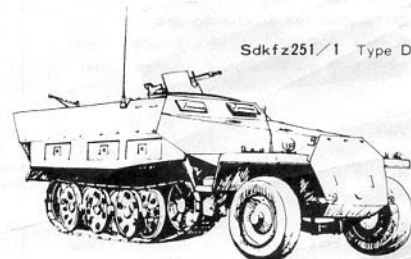

Sdkfz 251/1 Type D

# PARTS

## A PARTS

1. Head Light
2. Rear-View Mirror Leg
3. Leg
4. Rear-View Mirror
5. Hammer
6. Pickax
7. Crank
8. Fender, Right
9. Magazine
10. Gun Shield
11. MG 34 Machine Gun
12. MG 42 Machine Gun
13. Front Window
14. Seat
15. Side Window
16. Front Hook, Right
17. Front Hook, Left
18. Winker
19. Winker
20. Machine Gun Mount Part A
21. Machine Gun Mount Part B
22. Machine Gun Mount Part C
23. Rear Machine Gun Mount
24. Rail for Machine Gun
25. Fender, Left
26. Foremost Part of Body
27. Rear Door, Left
28. Rear Door, Right
29. Hinge, Left
30. Hinge, Right
31. Hinge Support, Lower
32. Hinge Support, Upper
33. Tool Box
34. Exhaust Port
35. Head Light Stay
36. Head Light
37. Head Light Stay
38. Shovel
39. Shovel

## B PARTS

1. Dash Board
2. Seat
3. Interior Part C
4. Brake Lever
5. Gear Shift Lever
6. Lever
7. Pedal
8. Case
9. Steering Wheel
10. Interior Part D
11. Interior Part A
12. Floor
13. Rear Part
14. Interior Part B
15. Tie Rod Support
16. Shaft A
17. Shaft C
18. Shaft B
19. Track Rod
20. Spring
21. Upright, Left
22. Upright, Right
23. Shaft Support
24. Fire Extinguisher
25. Suspension
26. Muffler Part A
27. Muffler Part B
28. Muffler Part B
29. Tie Rod

## C PARTS

1. Road Wheel A
2. Road Wheel C
3. Drive Sprocket A
4. Drive Sprocket B
5. Tail Light
6. Wheel Part
7. Hook
8. Front Wheel Part
9. Front Wheel
10. Road Wheel D
11. Road Wheel B

## FIGURE PARTS

1. MP 40
2. Kar 98K
3. MG 34
4. MP 40 Magazine Case
5. Magazine Case
6. Leg for MG 34
7. Water Bottle
8. Gas Mask Case
9. Holster
10. Binoculars
11. Bayonet
12. Helmet
13. Duffel Bag
14. Canteen



Please read this before commencing assembly.

★ You will require a pair of tweezers, a file and a sharp hobby knife to build your kit.

★ As this kit is composed of many fine parts, take good care when removing parts from the plastic sprues.

★ Always use glue very sparingly. Too much glue will spoil your finished model.

### (PAINTING)

★ You had better paint the body after the kit is completely assembled.

★ See the painting instructions given in page 7.

This mark shows in which colour to be painted.



**A**

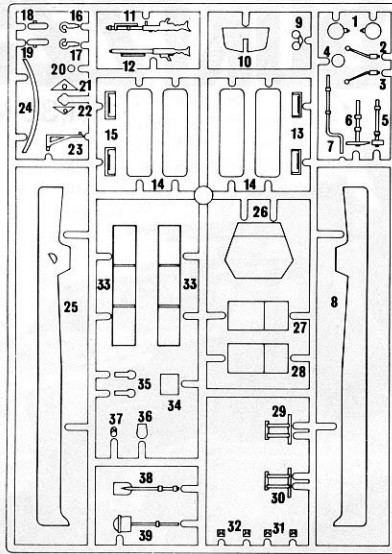

**B**

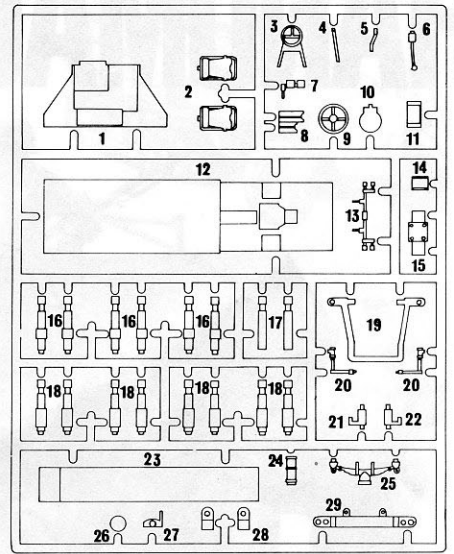

**C**

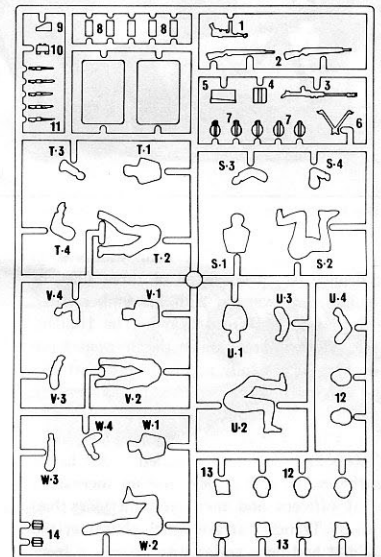
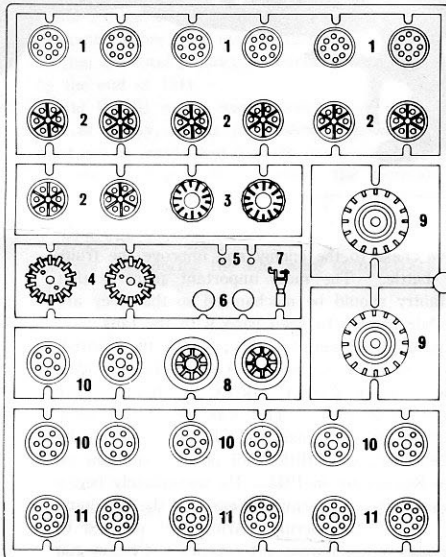

**1** Construction of Water Tank

**2** Assembly of Meter Panel

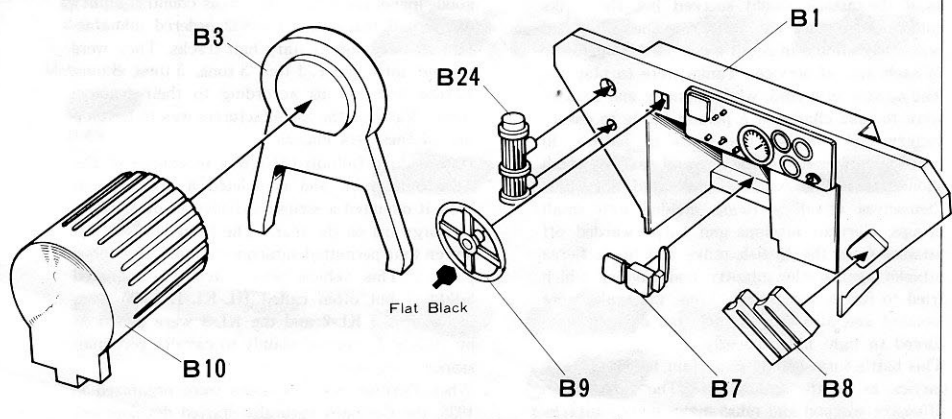

**<Construction of Floor>**

★To make the work easier, glue B4, B5 and B6 before fixing Dash Board.

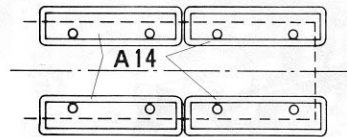

Be sure to fix A14 in proper position. The side with pins fixed below must face inward to the center line.

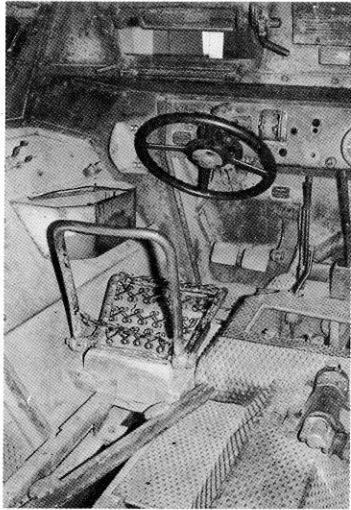

**<Fixing of Shafts>**

★Shafts (B16, B18) are movable.  
Do not use glue.  
★B23 is Shaft Support and must be glued securely.

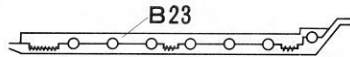

Apply adhesive to the shadowed portion shown in the figure above.

**<Fixing of Floor>**

Floor (B12) also serves as a drive-shaft support and must be glued securely. B17 is movable. Do not use glue.



**3 Construction of Floor**

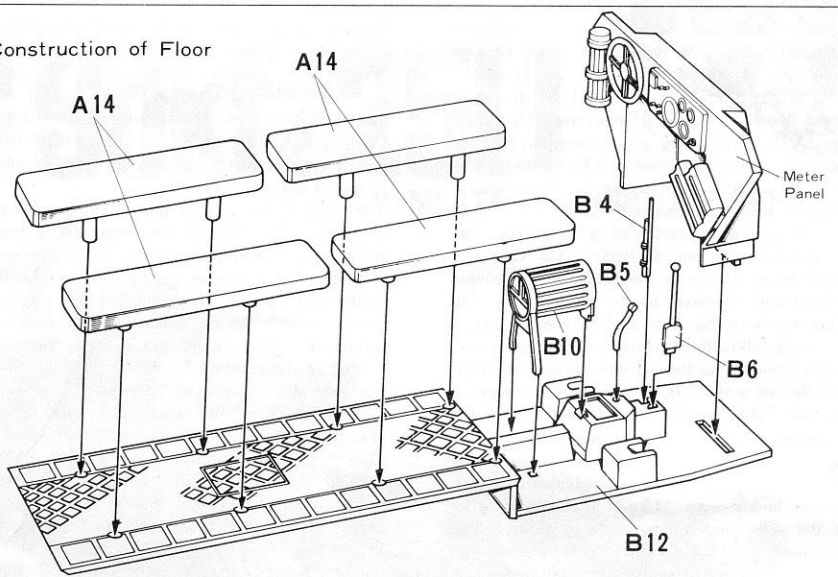

**4 Fixing of Shafts**

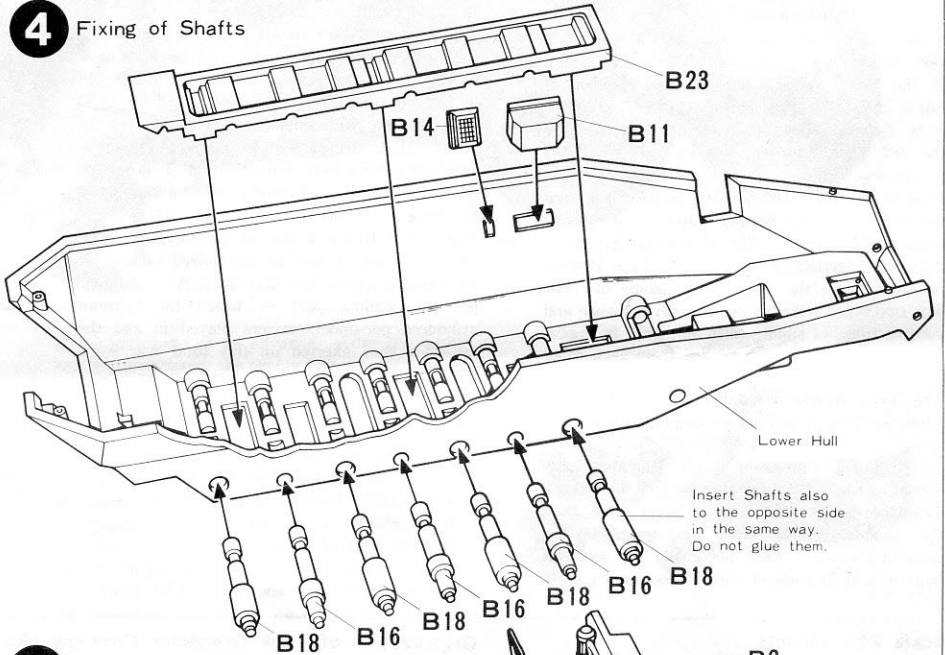

**5 Fixing of Floor**

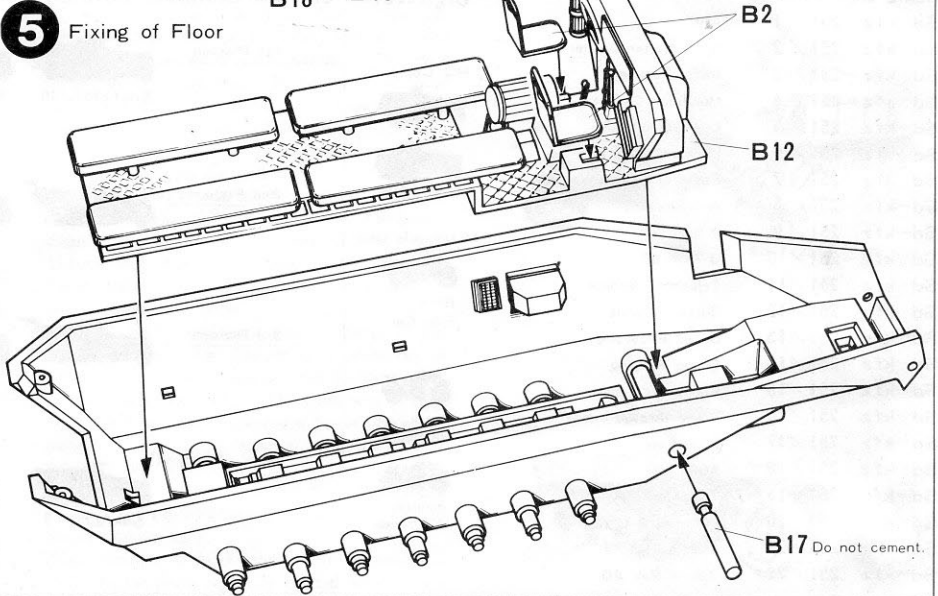

**6 (Construction of Wheels)**

C6 is movable. Do not use glue. When fixing C9 and C8 with adhesive, be care not to cement C6.

When gluing C4 to C3 and C10 to C2, be sure to insert pins into respective holes.

**7 (Construction of Front Axle)**

B19, B21 and B22 are movable.

Do not use glue.

**8 (Fixing of Wheels)**

When fixing Road Wheel, first fix C11 and then the completed wheel (C10 and C2), and then fix C1 with adhesive.

Front Axle and Track Rod (B19) must be held in place by means of B15. Do not glue them.

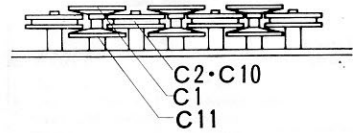

**9 (Construction of Rear Hatch)**

A30 and A29 are movable parts and must not be glued. Just insert them into A31 and A32.

**10 (Fixing of Upper Body)**

Rear Hatch is movable. Do not use glue. After gluing Upper Body to Lower Body, tie them together with rubber bands or tapes.

**(Construction and Fixing of Caterpillar)**  
Push "a" part into "b" part as shown in the figure below.

★Be careful of the direction of Caterpillar.

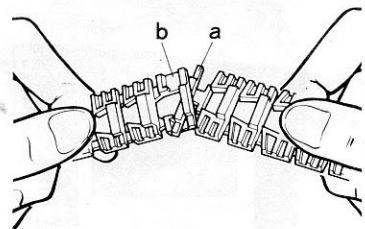

**6 Construction of Wheels**

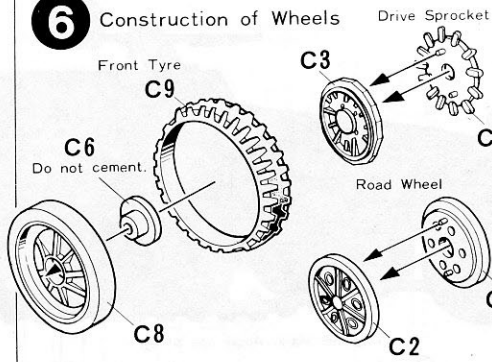

**7 Construction of Front Axle**

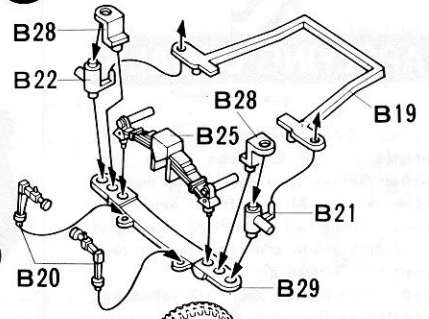

**8 Fixing of Wheels**

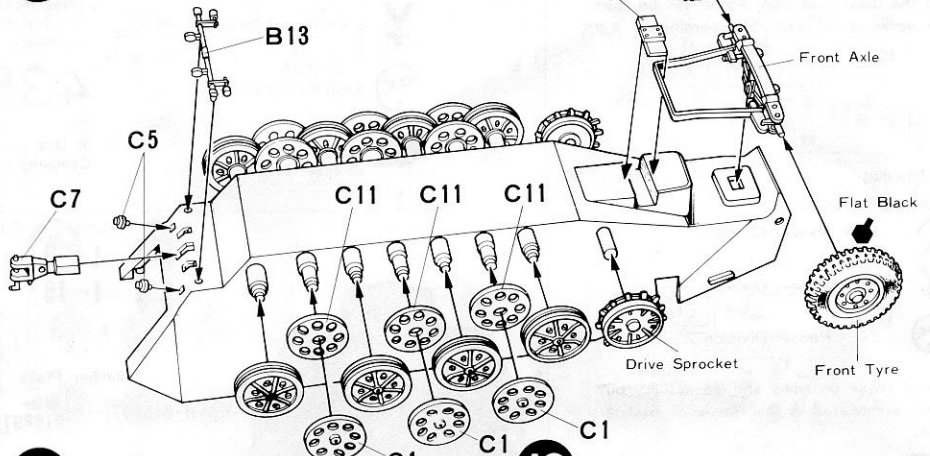

**9 Construction of Rear Hatch**

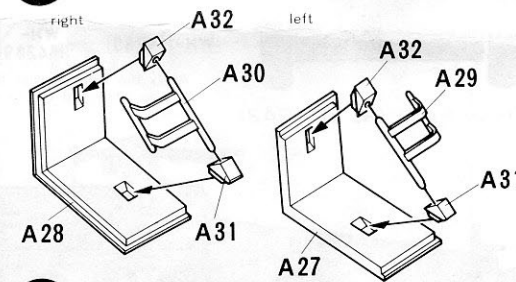

**10 Construction of Machine Gun Support**

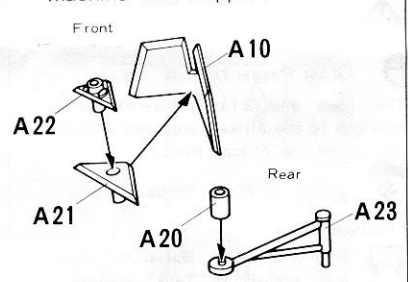

**11 Fixing of Upper Body**

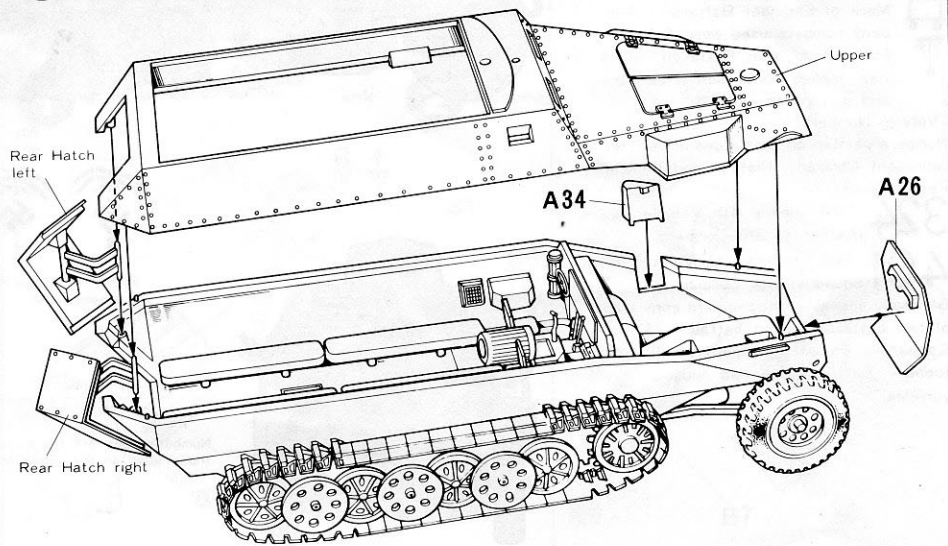

**12** (Fixing of Left Fender)  
 Fix the Fender securely.  
 See the figure below when fixing Head-light.

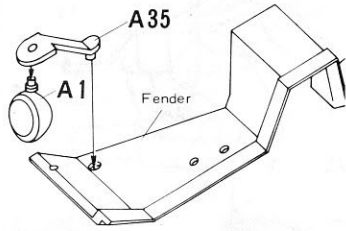

**13** (Fixing of Right Fender)  
 Fix Fender securely. For fixing of Head Light, see the figure above.

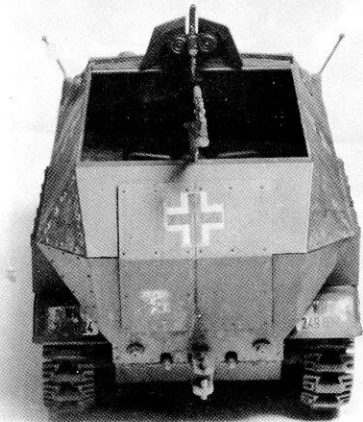
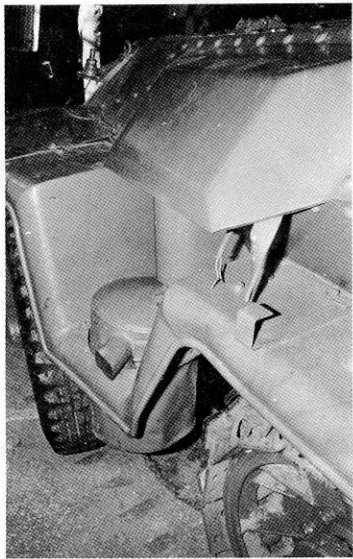

**12** Fixing of Left Fender

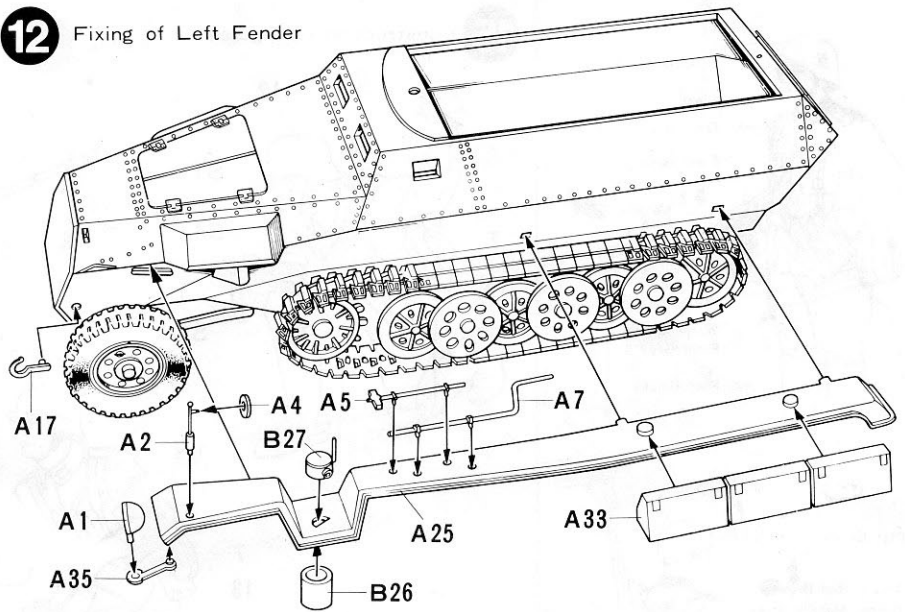

**13** Fixing of Right Fender

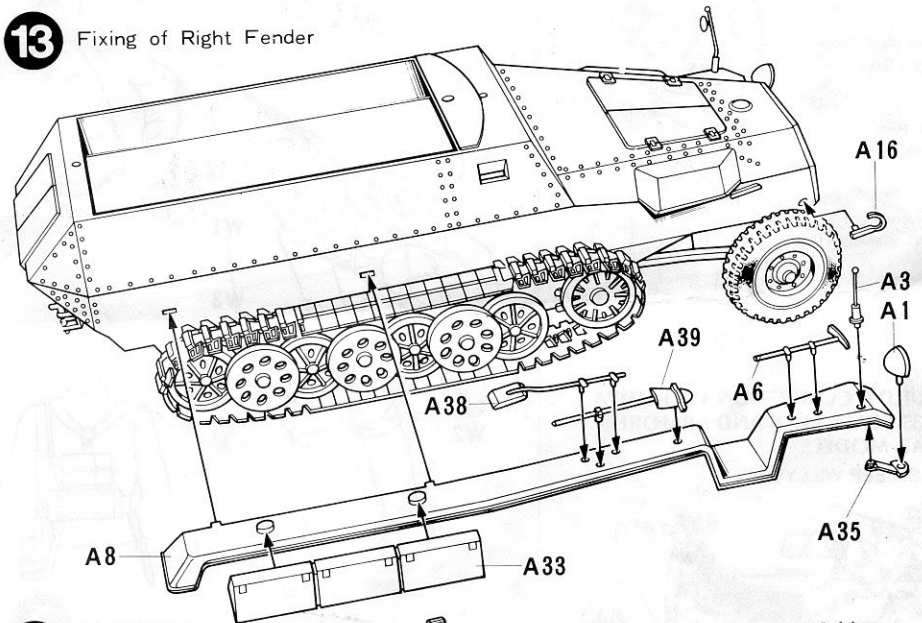

**14** Completion of the Model

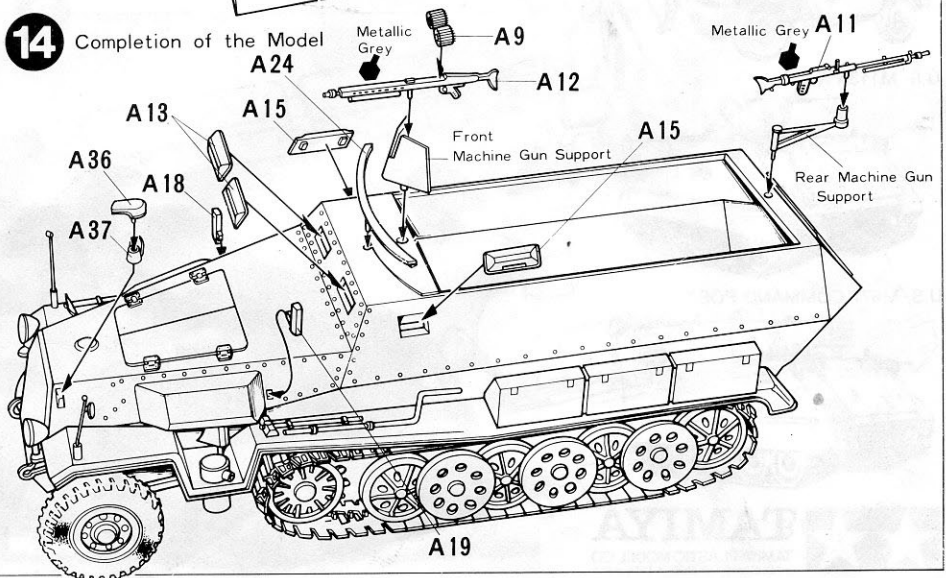

(Painting of Figure)



**BUILD A COLLECTION OF TAMIYA  
1/35 SCALE TANK AND ARMORED  
CAR MODELS**  
U.S. JEEP WILLYS® MB

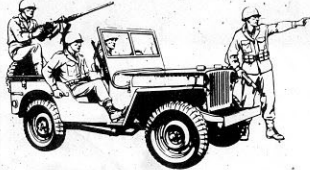

U.S. M113A A.P.C.



U.S. M577 COMMAND POST

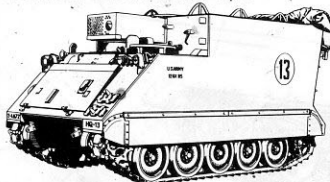

**TAMIYA**  
TAMIYA PLASTIC MODEL CO.  
3-7, ONDAWARA, SHIZUOKA-CITY, JAPAN.

**15** Construction of Figures

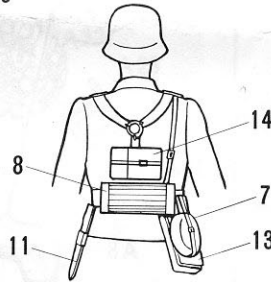
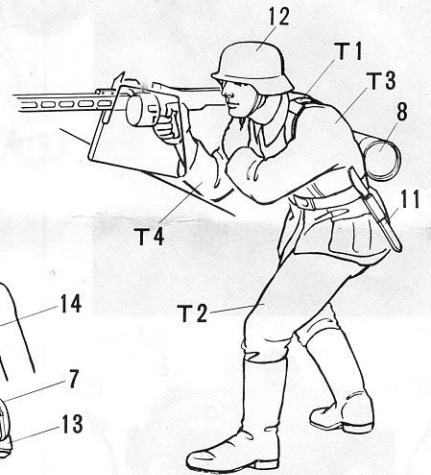
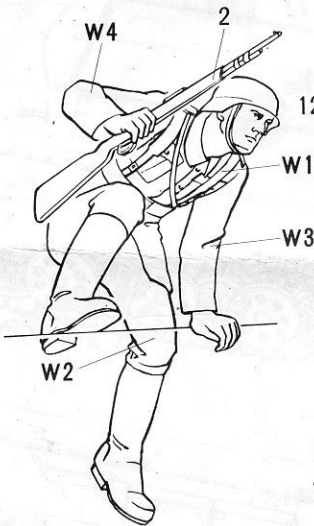
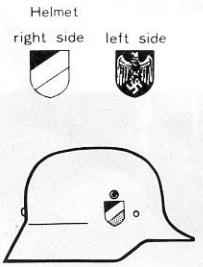
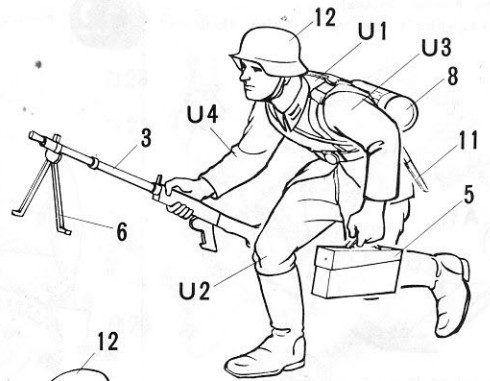

# PAINTING



# APPLYING DECALS



## Painting

Around 1942, most of German military vehicles on the European fronts were painted German grey overall and most of those on the African front were dark yellow. Some had camouflage painting of either dark yellow and red brown or dark green and German grey.

From 1943 onward, only dark yellow was accepted as the basic colour and camouflage painting of olive drab, red brown and/or German grey was applied according to the theater of war. Paint was brushed or sprayed on vehicles accordingly.

## MARKING

### (Divisional Marks)

-  14th Panzer-Division
-  16th Panzer-Division
-  24th Panzer-Division

All of these divisions showed activity but were annihilated in the Battle of Stalingrad.



-  Panzer-Division. (Grossdeutschland)
-  15th Panzer-Division

-  21st Panzer-Division

The 15th and 21st Panzer-Divisions belonged to the Afrika Korps and showed activity on the African front.

-  Symbol of Afrika Korps.

### (Tactical Marks)

-  Mark of Infantry Battalion. This was applied to Tank Grenadier Units. Company numbers used were 1-16.
-  Mark of Engineer Battalion. Company numbers used were 1-4.
-  Mark of AA Gun Battalion. This was applied to personnel carriers and ammunition cars.

### (Vehicle Numbers)

Numbers painted on both sides of vehicles represent Company, Platoon and Vehicle.

For instance:

**324** "324" means 4th Vehicle in 2nd Platoon of 3rd Company.



**401** "401" means 1st Vehicle in HQ Squad of 4th Company.

Generally speaking, one regiment consisted of two battalions, each battalion of four Companies, and each company of four platoons. Each platoon had four or five vehicles.

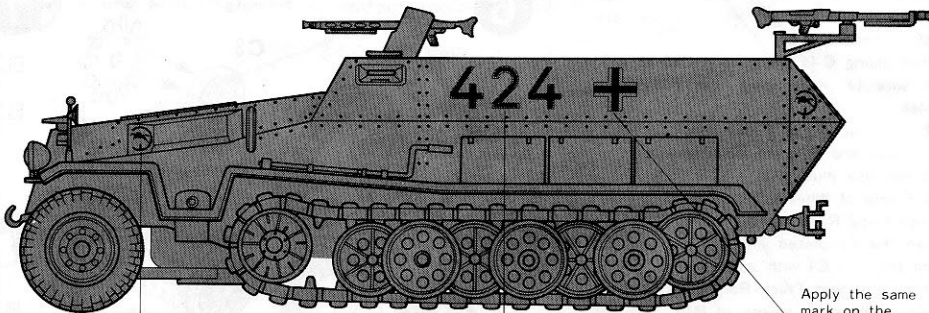
## Russian Front (As of 1942)



Divisional Mark (Apply one of these)

-  14th Panzer-Division
-  16th Panzer-Division
-  24th Panzer-Division
-  Panzer-Division (Grossdeutschland)

**125**

This means 5th Vehicle in 2nd Platoon of 1st Company.

**435**

This means 5th Vehicle in 3rd Platoon of 4th Company.

Apply the same mark on the opposite side.

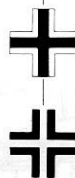

## MARKING

### (Divisional Marks)

-  14th Panzer-Division
-  16th Panzer-Division
-  24th Panzer-Division

All of these divisions showed activity but were annihilated in the Battle of Stalingrad.



-  Panzer-Division. (Grossdeutschland)
-  15th Panzer-Division

-  21st Panzer-Division

The 15th and 21st Panzer-Divisions belonged to the Afrika Korps and showed activity on the African front.

-  Symbol of Afrika Korps.

### (Tactical Marks)

-  Mark of Infantry Battalion. This was applied to Tank Grenadier Units. Company numbers used were 1-16.
-  Mark of Engineer Battalion. Company numbers used were 1-4.
-  Mark of AA Gun Battalion. This was applied to personnel carriers and ammunition cars.

### (Vehicle Numbers)

Numbers painted on both sides of vehicles represent Company, Platoon and Vehicle.

For instance:



**324** "324" means 4th Vehicle in 2nd Platoon of 3rd Company.

**401** "401" means 1st Vehicle in HQ Squad of 4th Company.

Generally speaking, one regiment consisted of two battalions, each battalion of four Companies, and each company of four platoons. Each platoon had four or five vehicles.

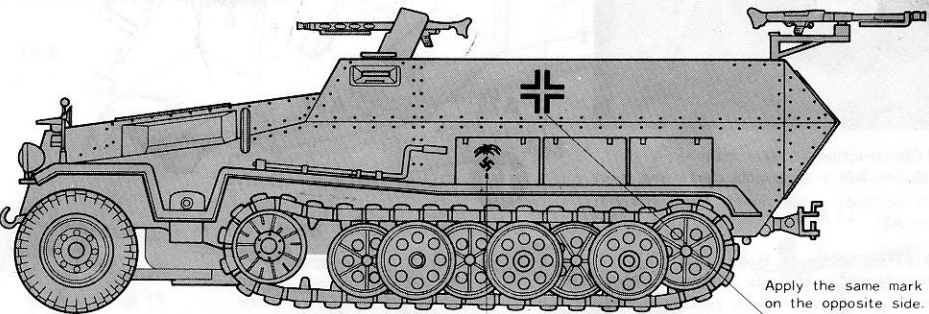
## African Front (As of 1942)



Number is Company Number.  
 1-4  
 1-16

Number Plate

- |           |           |           |
|-----------|-----------|-----------|
| WH-816297 | WH-816297 | WH-816297 |
| WH-939501 | WH-939501 | WH-939501 |
| WH-154289 | WH-154289 | WH-154289 |

Apply the same number both to the front and to the rear.

Apply the same mark on the opposite side.



 



Symbol of Afrika Korps (Choose one.)

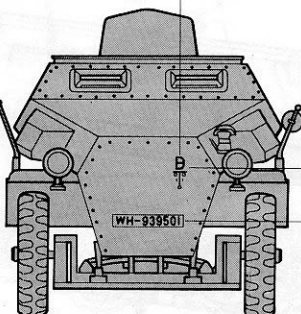

Number plates are the same as those used on the 'Russian Front'.

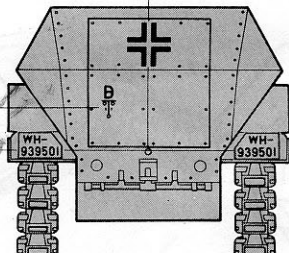

plan for vehicles carrying infantrymen to support tank forces. In 1938, the German Army decided to develop an armoured personnel carrier on the basis of the 3-ton half track (HL-KL-9p) mentioned above. Hanomag Hamoversch Maschinenbau (AG) in Hannover was ordered to develop the running gear and Büssing-NAG in Berlin was to develop the superstructure to be armoured. Design work was hastened on the model of existing armoured cars and a prototype was completed at the end of 1938. The Germans tested the prototype in the Kumahsdorf Proving Ground and accepted it for mass production. Thus was born the Armoured Personnel Carrier Hanomag Sdkfz 251/1 which, we may safely say, was a synonym for the German mechanized corps that showed activity in all battlefields throughout the war. The Type A (the first production type) employed a Maybach HL 42, 6-cylinder 4,171 cc engine of 100 hp. The transmission permitted four speeds forward and one backward. The armour thickness was 14.5 mm at the front, 8 mm on the sides and 6 mm at the bottom. The maximum speed was 55 km/h. This vehicle could carry 12 fully armed soldiers in addition to tow crew-members. Production was immediately started by Hanomag and Goliath. In 1942, Adler-Werke AG, Auto-Union and Skoda of Pilsen (now in Czechoslovakia) joined them.

In the Polish Campaign, a limited number of Sdkfz 251's first saw battle on 9th September, 1939. General Heinz Guderian in command of the 3rd Tank Division was in a Sdkfz 251/3 which was equipped as a commander's vehicle. Making full use of its mobility, he moved around the battlefield and became famous for his undaunted command. The Hanomag Armoured Personnel Carriers of Type A and Type B were produced until the French Campaign of 1940. The two types were the same in performance and construction but slightly different only in appearance. They were distinguished from each other by soldiers, peep windows on the body sides. The Type A had a number of such windows, while the Type B had none except for the driver's ones.

In the Polish Campaign where Hanomag personnel carriers first saw action and the French Campaign which was started soon after that, the advantages of infantry mechanized by the personnel carriers were not made the most of from a tactical point of view. This is not merely

because the personnel carriers used were limited in number but because they were often used by machine-gun platoons and engineer companies and for towing infantry guns rather than for carrying infantrymen. It was not until the Russian Campaign which started in 1941 that fully mechanized infantry exercised its terrible power in united action with tanks.

The Type C was put to production at the end of 1940. The Type C was improved in body construction and employed 100% welding process in place of the former combination process of bolting and welding. Three shielded light machine guns of model 34 were mounted as the standard equipment. The armour was equal in thickness to that of the previous types. In 1941, the Type was officially designated "Armoured Personnel Carrier (SPW)". Until the Type D appeared in 1943, the Type C played an important part in support of German tank forces in the gallant days of blitzkrieg against Russia from the Operation Barbarossa to the Battle of Stalingrad. Especially in the German Summer Offensive of 1942 which the Russian leaders referred to as "Gloomy Summer of 1942", German tank divisions used a great number of Type C's and drove the Russians back to the Volga.

The Armoured Personnel Carrier developed into the further improved Type D and came to have a wide variety of equipment and armament. In all, 22 variations ranging from the Sdkfz 251/1 equipped only with shielded machine guns to the Sdkfz 251/22 armed with a 75 mm AT gun of 48 length calibre were manufactured. It is reported that the total production reached about 16,000 by the end of 1944.

World War II was a war of mechanized power, that is to say, a war of systemized power. It must not be overlooked that the part — although not the leading part — which the German armoured personnel carriers played in and the influence they exerted on this total war were very great and also that most of personnel carriers used during the war were of half-track type.



Sdkfz251 / 9

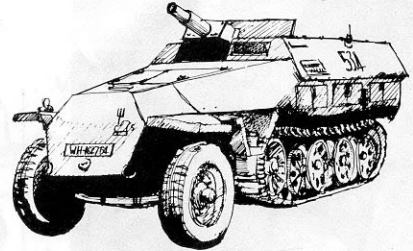

Sdkfz251 / 17

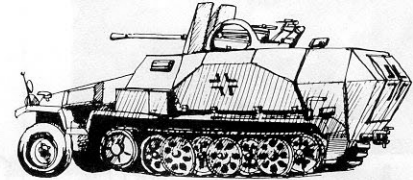

Sdkfz251 / 1 28 cm Projectors

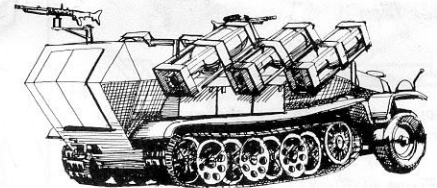

Sdkfz 251 variants

- Sd-kfz 251 / 1 APC
- Sd-kfz 251 / 2 8 cm Mortar Carrier
- Sd-kfz 251 / 3 Radio Vehicle
- Sd-kfz 251 / 4 Munitions Carrier
- Sd-kfz 251 / 5 Engineer Vehicle
- Sd-kfz 251 / 6 Command Vehicle
- Sd-kfz 251 / 7 Engineer Stores Vehicle
- Sd-kfz 251 / 8 Ambulance
- Sd-kfz 251 / 9 7.5 cm SP
- Sd-kfz 251 / 10 3.7 cm SP
- Sd-kfz 251 / 11 Telephone Vehicle
- Sd-kfz 251 / 12 Survey Vehicle
- Sd-kfz 251 / 13 Sound Recording
- Sd-kfz 251 / 14 Sound Ranging
- Sd-kfz 251 / 15 Flash Recording
- Sd-kfz 251 / 16 Flame-thrower
- Sd-kfz 251 / 17 2 cm Flak
- Sd-kfz 251 / 18 AOP
- Sd-kfz 251 / 19 Telephone Relay
- Sd-kfz 251 / 20 Infra-red S L Carrier
- Sd-kfz 251 / 21 1.5 cm Flak
- Sd-kfz 251 / 22 7.5 cm Pak 40

Organization of Tank Grenadier Company (As of 1942)

